

VT2



Ordering code:: VML 360 VT2 DALI



ELECTRICAL FEATURES

Wattage	60 W
Supply voltage	198 - 264 VAC / 190 - 280 VDC
Power factor	0.98
Total harmonic distortion	<15
IEC Protection Class	I
Energy class	A+
Dimming	DALI
Qty. per MCB C 16A	30 pcs
LED driver lifespan	100 000 hod. @ t _c =65°

OPTICAL FEATURES

Lamp luminous flux	6700 lm
Luminous efficiency	112 lm/W
Color temperature	3K / 4K / 5K
Color rendering index	80+
Chromaticity tolerance	3 step MacAdam
Viewing angle	-
Unified glare rating	-
Luminance @65° < 3000 cd/m ²	yes
LED lifespan	L ₈₀ / B ₁₀ = 75 000 hod. @ 65°C

MECHANICAL FEATURES

Dimensions	1195 x 295 x 65 mm
Weight	4.5 kg
Operating temperature	- 25 ~ + 25 °C
Protection class	IP 40
Body material	lakovaný Fe plech
Reflector material	Al
Diffuser material	PMMA
Mounting method	recessed

POLAR DIAGRAM

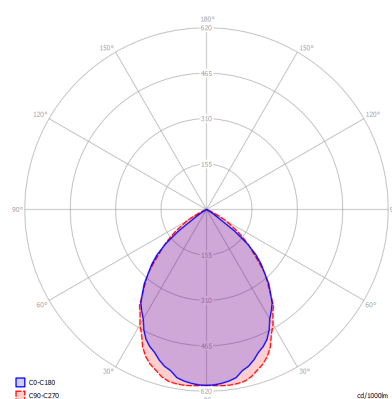

DIMENSIONS

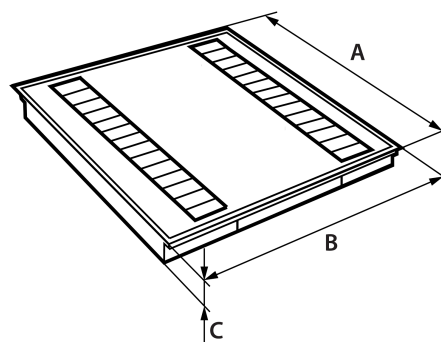

ON REQUEST

CCT 2700K, 3500K, 5700K, 6500K
 CRI > 90Ra
 Customized power
 Customized cable
 Connectors Gesis GST, RST
 Kit for plasterboard
 Customized RAL color
 Emergency source 1 hr/3 hrs

Tolerance of data ± 7.5%

Rights to make printing errors, changes in design and lighting specifications are reserved.

VM elektro s.r.o.
 č.p. 241
 763 01 Machová

vm elektro®

tel: +420 577 102 293-4
 tel: +420 573 034 581-2
 e-mail: info@vmelektro.cz