

# P2L



Ordering code:: VML 140 P2L MM DALI



## ELECTRICAL FEATURES

Wattage	40 W
Supply voltage	198 - 264 VAC / 190 - 280 VDC
Power factor	0.98
Total harmonic distortion	<15
IEC Protection Class	I
Energy class	A+
Dimming	DALI
Qty. per MCB C 16A	53 pcs
LED driver lifespan	100 000 hod. @ $t_c=65^\circ$

## OPTICAL FEATURES

Lamp luminous flux	4640 lm
Luminous efficiency	116 lm/W
Color temperature	3K / 4K / 5K
Color rendering index	80+
Chromaticity tolerance	3 step MacAdam
Viewing angle	-
Unified glare rating	21.7/24.4
Luminance @65° < 3000 cd/m <sup>2</sup>	-
LED lifespan	$L_{80} / B_{10} = 75\ 000$ hod. @ 65°C

## MECHANICAL FEATURES

Dimensions	600 x 620 x 55 mm
Weight	4 kg
Operating temperature	- 25 ~ + 25 °C
Protection class	IP 40
Body material	lakovaný Fe plech
Reflector material	Al
Diffuser material	PMMA
Mounting method	přisazená nebo závěsná

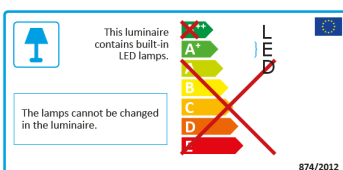

## POLAR DIAGRAM

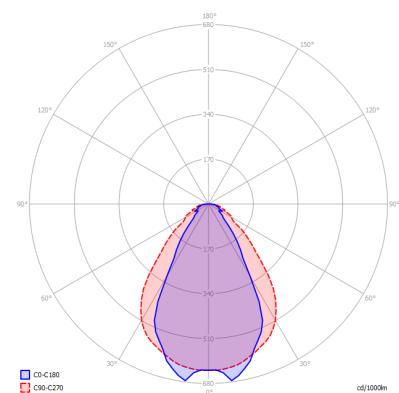

## DIMENSIONS

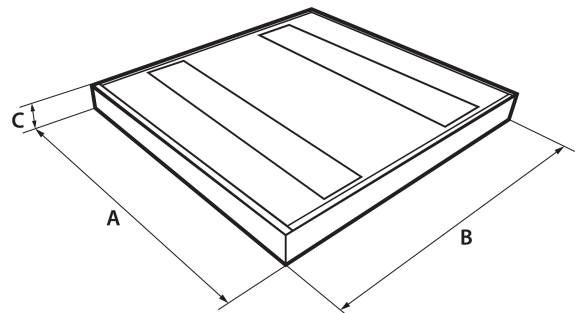

## ON REQUEST

- CCT 2700K, 3500K, 5700K, 6500K
- CRI > 90Ra
- Customized power
- Customized cable
- Connectors Gesis GST, RST
- Suspension rope kit
- Customized RAL color
- Emergency source 1 hr/3 hrs

Tolerance of data ± 7.5%

Rights to make printing errors, changes in design and lighting specifications are reserved.

VM elektro s.r.o.  
č.p. 241  
763 01 Machová

**vm** elektro®

tel: +420 577 102 293-4  
tel: +420 573 034 581-2  
e-mail: info@vmelektro.cz